

banks

with Installation Instructions
Owner's Manual

**Banks Big Hoss®
Diesel Tuner**
(Does Not Connect to Pump Wire)

**1998-2002 Dodge 5.9L Cummins
(24-valve) ISB Pickup Trucks**

THIS MANUAL IS FOR USE WITH SYSTEMS 62781-62783

Gale Banks Engineering
546 Duggan Avenue • Azusa, CA 91702
(626) 969-9600 • Fax (626) 334-1743

Product Information & Sales: (888) 635-4565
Customer Support: (888) 839-5600
Installation Support: (888) 839-2700

bankpower.com

Product available from Banks Power for the 1998-2002 Dodge 5.9L

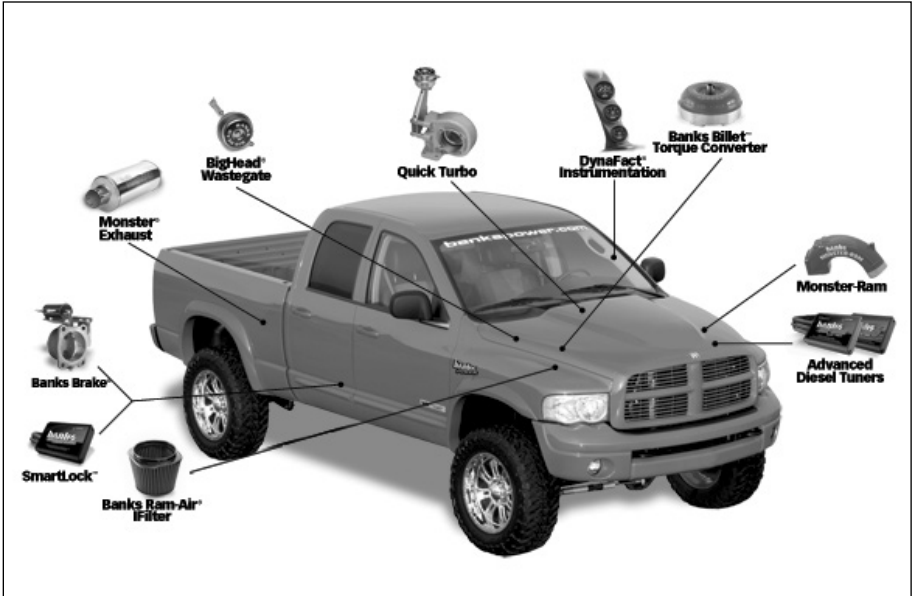

Banks Monster® Exhaust System 98-02 (P/N 48635-48638)

- Increases exhaust flow, cuts backpressure, lowers exhaust gas temperatures (EGTs) and increases power.

Banks Monster-Ram 98-02 (P/N 42764)

- Increased flow from intercooler
- Raises boost without increasing backpressure at the turbine

Banks Exhaust Brake 98-02 (P/N 55219, 55221)

- Increases the stopping power of your truck and extends the service life of your brakes

Banks SmartLock 98-02 (P/N 55262)

- Reduces wear on transmission
- Locks Torque Converter and raises trans-line pressure
- Works with Banks Exhaust Brake

Thermocouple

- Add a temperature limiting function to your Diesel Tuner .

Banks QuickTurbo 94-02 (P/N 24052, 24053)

- More boost through the powerband
- Does not over-boost
- Turbo-diesel efficiency

Banks BigHead® Actuator 98-02 (P/N 24329)

- Achieves a higher peak boost over stock and gives you precise boost control that gives you crisp acceleration and more mid-range pulling power.

Banks Billet Torque Converter 94-07 (P/N 72515)

- Higher torque capacity over stock
- Lockup clutch is slip-resistant so transmission fluids stay cooler and transmission life is prolonged.

Banks Git-Kit Systems**98-02 (P/N 49357-49362)****Contains:**

- Monster Exhaust
- OttoMind Tuner

Banks Stinger Systems**98-02 (P/N 49363-49374)****Contains:**

- Ram-Air Filter
- Monster Exhaust
- OttoMind Tuner
- Big Head Wastegate Actuator
- Gauges

Banks Stinger-Plus Systems**98-02 (P/N 49320-49323, 49351, 49352)****Contains:**

- Ram-Air Filter
- Monster Exhaust
- OttoMind Tuner
- Big Head Wastegate Actuator
- Gauges
- Quick Turbo

Banks PowerPack Systems**98-02 (P/N 49330-49335, 49353-49356)****Contains:**

- Ram-Air Filter
- Monster-Ram
- Monster Exhaust
- OttoMind Tuner
- Big Head Wastegate Actuator
- Gauges
- Quick Turbo

**For More Information please call (888) 635-4565
or Visit us online @ www.bankspower.com**

THIS IS A HIGH PERFORMANCE PRODUCT. USE AT YOUR OWN RISK.

Do not use this product until you have carefully read the following agreement.

This sets forth the terms and conditions for the use of this product. The installation of this product indicates that the **BUYER** has read and understands this agreement and accepts its terms and conditions.

Disclaimer of Liability

Gale Banks Engineering Inc., and its distributors, employees, and dealers (hereafter "**SELLER**") shall in no way be responsible for the product's proper use and service. The **BUYER** hereby waives all liability claims.

The **BUYER** acknowledges that he/she is not relying on the **SELLER's** skill or judgment to select or furnish goods suitable for any particular purpose and that there are no liabilities which extended beyond the description on the face hereof and the **BUYER** hereby waives all remedies or liabilities, expressed or implied, arising by law or otherwise, (including without any obligations of the **SELLER** with respect to fitness, merchantability, and consequential damages) whether or not occasioned by the **SELLER's** negligence.

The **BUYER** is responsible to fully understand the capability and limitations of his/her vehicle according to manufacturer specifications and agrees to hold the **SELLER** harmless from any damage resulting from the failure to adhere to such specifications.

The **SELLER** disclaims any warranty and expressly disclaims any liability for personal injury or damages. The **BUYER** acknowledges and agrees that the disclaimer of any liability for personal injury is a material term for this agreement and the **BUYER** agrees to indemnify the **SELLER** and to hold the **SELLER** harmless from any claim related to the item of the equipment purchased. Under no circumstances will the **SELLER** be liable for any damages or expenses by reason of the use or sale of any such equipment.

The **BUYER** is responsible to obey all applicable federal, state, and local laws, statutes, and ordinances when operating his/her vehicle, and the **BUYER** agrees to hold **SELLER** harmless from any violation thereof.

The **SELLER** assumes no liability regarding the improper installation or misapplication of its products. It is the installer's responsibility to check for proper installation and if in doubt, contact the manufacturer.

The **BUYER** is solely responsible for all warranty issues from the automotive manufacturer.

Limitation of Warranty

Gale Banks Engineering Inc. (hereafter "**SELLER**"), gives Limited Warranty as to description, quality, merchantability, fitness for any particular purpose, productiveness, or any other matter of **SELLER's** product sold herewith. The **SELLER** shall be in no way responsible for the product's open use and service and the **BUYER** hereby waives all rights except those expressly written herein. This Warranty shall not be extended or varied except by written instrument signed by **SELLER** and **BUYER**.

Please see enclosed warranty information card, or go to www.bankspower.com, for warranty information regarding your product. All products that are in question of Warranty must be returned shipping prepaid to the **SELLER** and must be accompanied by a dated proof of purchase receipt. All Warranty claims are subject to approval by Gale Banks Engineering Inc.

Under no circumstance shall the **SELLER** be liable for any labor charged or travel time incurred in diagnosis for defects, removal, or reinstallation of this product, or any other contingent expense.

Under no circumstances will the **SELLER** be liable for any damage or expenses incurred by reason of the use or sale of any such equipment.

IN THE EVENT THAT THE BUYER DOES NOT AGREE WITH THIS AGREEMENT:

The **BUYER** may promptly return this product, in a new and unused condition, with a dated proof-of-purchase, to the place-of-purchase within thirty (30) days from date-of-purchase for a full refund, less shipping and/or restocking fee.

The installation of this product indicates that the **BUYER** has read and understands this agreement and accepts its terms and conditions.

Table of Contents

General Installation Practices..... 6
 Recommended practices, tools, and supplies for installation

Section 17
 Big Hoss Diesel Tuner Installation

Section 2 13
 Checking Engine Performance

Section 3 15
 Big Hoss Mounting

General Installation Practices

Dear Customer,
If you have any questions concerning the installation of your Banks Big Hoss Diesel Tuner, please call our Technical Service Hotline at (888) 839-2700 between 7:00 am and 5:00 pm (PT). If you have any questions relating to shipping or billing, please contact our Customer Service Department at (888) 839-5600.
Thank you.

1. For ease of installation of your Banks Big Hoss Diesel Tuner, familiarize yourself with the procedure by reading the entire manual before starting work. This instruction manual contains 16 pages of text and illustrations.
2. Throughout this manual, the left side of the vehicle refers to the driver's side, and the right side to the passenger's side.
3. Disconnect the ground cable from the battery before beginning work. If there are two batteries, disconnect both.
4. Route and tie wires and hoses a minimum of 6 inches away from exhaust heat, moving parts and sharp edges. Clearance of 8 inches or more is recommended where possible.
5. The installation should be performed at a time when the vehicle has been allowed to completely cool. This installation requires the installer to work near surfaces that may remain hot after the vehicle has been run. Failure to allow the vehicle to cool may result in personal injury.
6. During installation, keep your work area and components clean.

Tools Required:

These tools are necessary for installation:

- Standard and Phillips head screwdrivers
- Standard and needle-nose pliers
- Pocket or X-Acto knife
- Clean shop towels or rags

Recommended airflow improvements:

1. Banks Monster® Exhaust
 - Standard Cab 48635
 - Extended Cab 48636
2. Banks BigHead® Actuator
 - 1998 ISB 24328
 - 1999-2000 ISB 24329
 - 2001-2002 ISB 245 HP 24329
3. Banks Ram-Air®
 - Filter 41027
 - Service Kit. 90094
4. Gauge Assembly
 - Boost and Pyro. 64505
5. Thermocouple. 63042
6. Lead wire. 63060
7. Turbine Inlet Gasket. 93027

Attention!

Before proceeding with these instructions, please carefully read the **DISCLAIMER OF LIABILITY** and **LIMITATION OF WARRANTY** statement located on page 4 of this manual.

Section 1

BIG HOSS DIESEL TUNER INSTALLATION

1. For automatic transmission models, locate and remove the rubber plug mounted in the firewall slightly above and to the right of the steering shaft, as viewed facing the firewall through the engine compartment. Make a cross-shaped incision in the plug and reinstall it in the firewall. See **Figure 1**.

For manual transmission models, make an incision in the main wiring loom grommet above the wire bundle. Take care to not cut any wiring. See **Figure 1**.

2. Remove three Phillips-head screws from the trim panel below the steering column and remove panel by pulling directly toward the rear of the vehicle. Retain the screws for re-installation. Use caution to avoid damaging the panel during removal.

3. Insert the end of the provided Big Hoss wire loom with the 8- and 10-pin connectors through the grommet from the engine compartment. Pull the Big Hoss wire loom from inside the cab until approximately 18" of the wire loom is inside the cab.

4. For automatic transmission only: Insert the end of the provided TCC wire harness with the 4-pin connector through the grommet from the engine compartment side using the same hole. Pull the TCC wire harness from inside the cab until approximately 18" of the harness is inside.

NOTE that the TCC wire harness is not applicable on vehicles with a manual transmission.

Figure 1

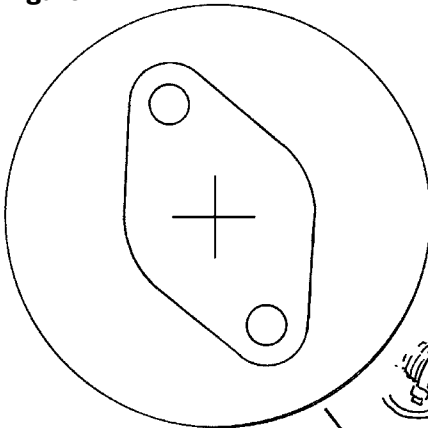

**AUTOMATIC
TRANSMISSION
VEHICLES:**

MAKE A CROSS-SHAPED
INCISION IN THE LARGE
RUBBER PLUG.

**MANUAL
TRANSMISSION VEHICLES:**

CUT A 3/4" SLIT IN THE BOOT ON THE
LARGE WIRING HARNESS GROMMET.

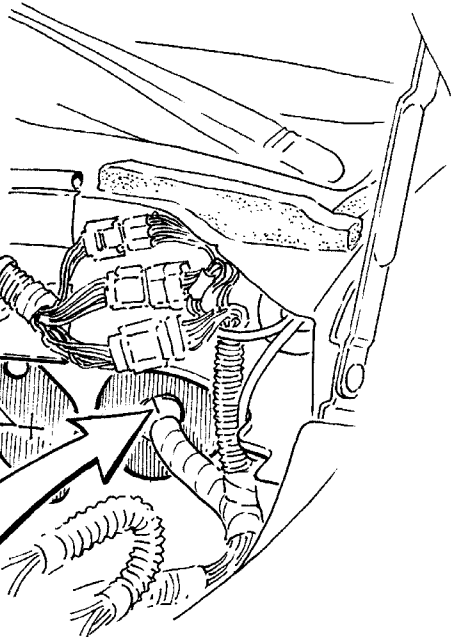

NOTE: Taping the end of the harness to a piece of stiff wire (i.e. coat hanger) may make routing the harness through the firewall a simpler task. The stiff wire should be pushed through the slit in the grommet and then the wires can be attached to the stiff wire and pulled through the hole in the firewall.

5. In the engine compartment, locate the CAN BUS connector on the left hand's side of the engine:

FOR 1998.5 TO 2000 VEHICLES: The CAN BUS connector is triangular shaped and near the power steering pump. Remove the weather seal plug. Insert the Big Hoss wire harness CAN BUS connector into this connector. However for some 1999 and 2000 vehicles, the CAN BUS connector could be a flat 3-pin connector. Use the provided CAN BUS adapter wire and plug it into the triangular connector on the Big Hoss wire harness, then follow 2001-2002 CAN BUS installation procedure.

FOR 2001 TO 2002 VEHICLES: The CAN BUS connector is a flat 3-pin connector located on top of the fuel lift pump below the Manifold Absolute Pressure (MAP) sensor. Remove the weather seal plug and insert Big Hoss CAN BUS connector into this connector.

6. Locate the Manifold Absolute Pressure (MAP) sensor on the left-hand side of the intake manifold next to the fuel pump. Unplug the factory connection, and plug the corresponding connectors on the Big Hoss wire loom into the sensor and the factory wire loom. See **Figure 2**.

*For trucks equipped with a manual transmission, skip to **Step 13**.*

7. On automatic transmission models, locate the PCM (rectangular metal box with three connectors mounted on the passenger's side of the firewall) in the engine compartment. See **Figure 3**.

8. Make sure that the ignition is off, then disconnect all three connectors from the PCM for easier accessibility to the wires.

9. Select the center (usually white) connector and locate the wire in the No.11 connector pin cavity. This will typically be an ORANGE wire with a BLACK tracer stripe. Install a RED T-Tap connector on this wire approximately 2-3 inches from the white connector body.

10. Plug the three cable connectors back into the PCM. The connector bodies are indexed so they cannot be installed in the wrong location.

11. Locate the long GRAY wire on the Banks TCC wire harness. Route this wire with the factory wire loom across the base of the cowl and over to the PCM. Plug the wire into the T-Tap installed on the No.11 pin wire at the center PCM connector. See **Figure 3**.

12. Find the solid RED wire located in the wiring harness in the engine compartment on the driver side as shown in **Figure 4**, and install a RED T-tap. Plug the BLUE TCC wire into the T-tap.

13. Inside the cab, plug the main 8- and 10-pin connectors from the wire loom into the Big Hoss Diesel Tuner box. On vehicle with automatic transmission, plug the TCC wire harness into the Big Hoss Diesel Tuner box.

*If you have a 1998-2001 vehicle, proceed to **Step 14a**. If you have a 2002 vehicle, proceed to **Step 14b**.*

14a. For 1998-2001 vehicles, locate the 10 gauge DARK BLUE wire on the wire harness running along the right side of the steering column. Install a YELLOW T-tap on this wire. Plug the RED Big Hoss wire into this T-tap. See **Figure 5a**. Proceed to **Step 15**.

Figure 2

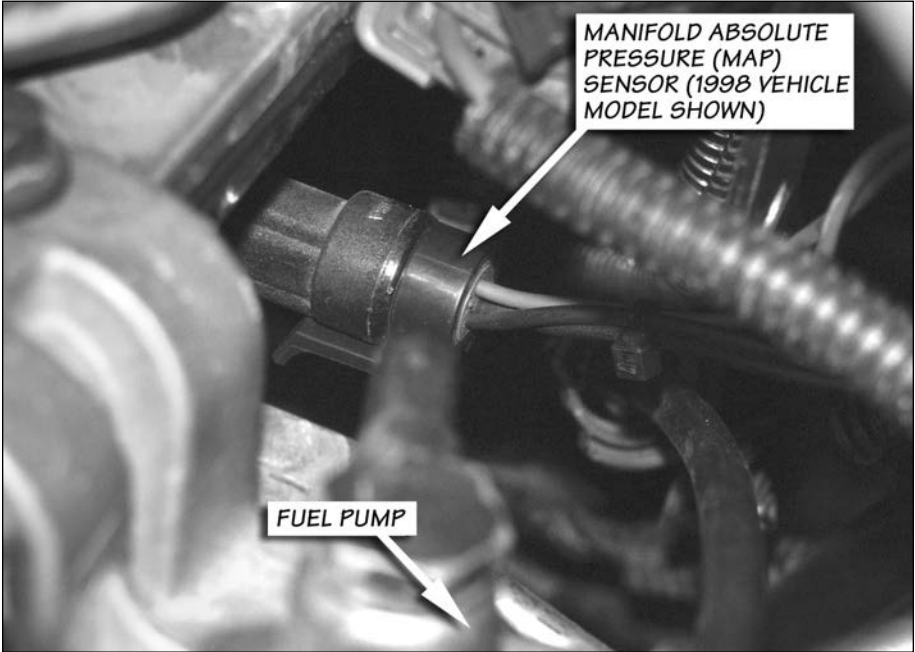

Figure 3

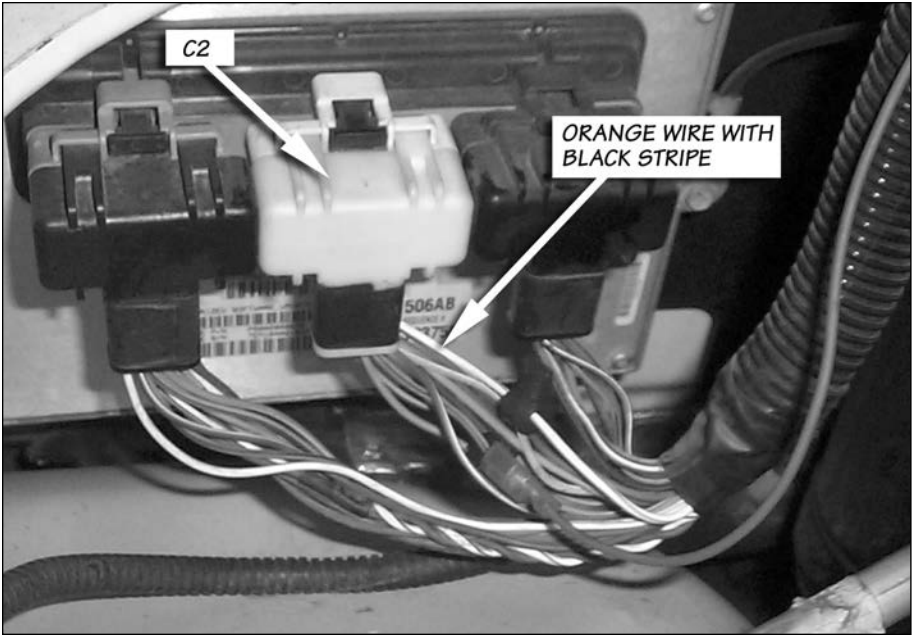

Figure 4

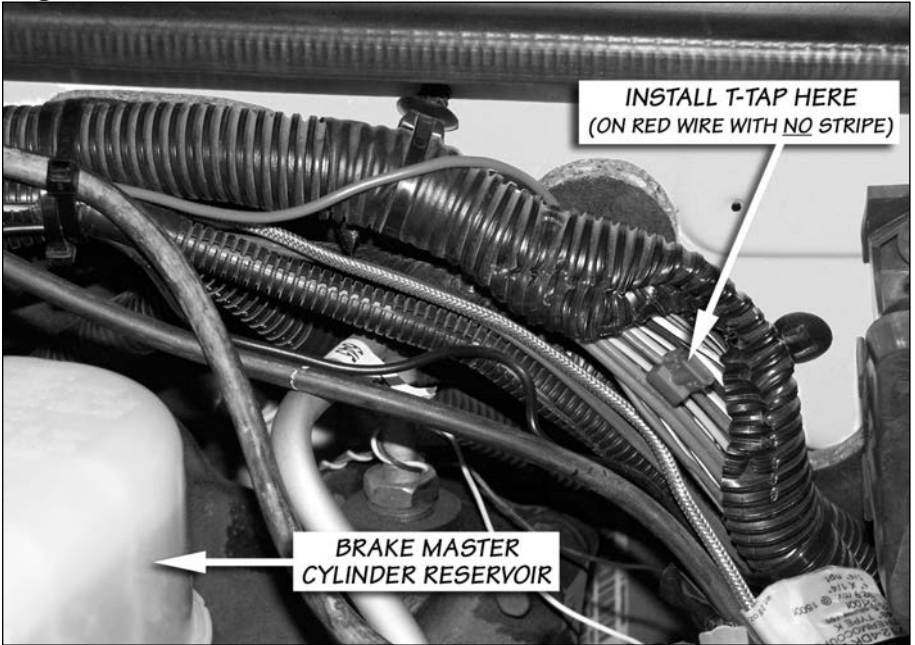
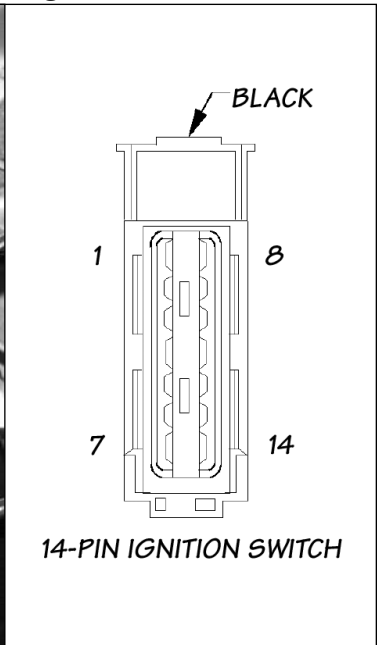

Figure 5a



Figure 5b



14b. For 2002 vehicles only, remove the steering column lower shroud by removing the 4 torx bolts. Check the ignition switch to see if it has a 7-pin or 14-pin connector. Refer to **Figure 5b** for the 14-pin ignition switch.

If your vehicle has a 7-pin ignition switch, locate the 10 gauge DARK BLUE wire at the switch. Trace this wire and install a YELLOW T-tap at the location as shown in **Figure 5a**. Plug the RED Big Hoss wire into this T-tap. Re-install the steering column lower shroud. Proceed to **Step 15**.

If your vehicle has a 14-pin ignition switch, locate the 16 gauge DARK BLUE wire on the switch at Pin #3. See **Figure 5b**.

DO NOT use the 10 gauge DARK BLUE wire. Trace this 16 gauge DARK BLUE wire and install a RED T-tap at the

location as shown in **Figure 5a**. Plug the RED Big Hoss wire into this T-tap. Re-install the steering column lower shroud.

15. Find the small bolt located at the lower left hand corner as shown in **Figure 6**. Remove it and install the Big Hoss wire ring terminal at this location. Reinstall the bolt to secure the ring terminal.

*NOTE: At this point in the installation process, it is necessary to determine which model turbocharger your vehicle is equipped with. A turbocharger identification tag is located on the front of the compressor housing of the turbo or on the actuator. If your turbocharger is an HY35W, skip to "Checking Engine Performance" on page 11 and complete **Steps 19** through **21** at the end. If the turbo is not HY35W, continue to **Step 16**.*

Figure 6

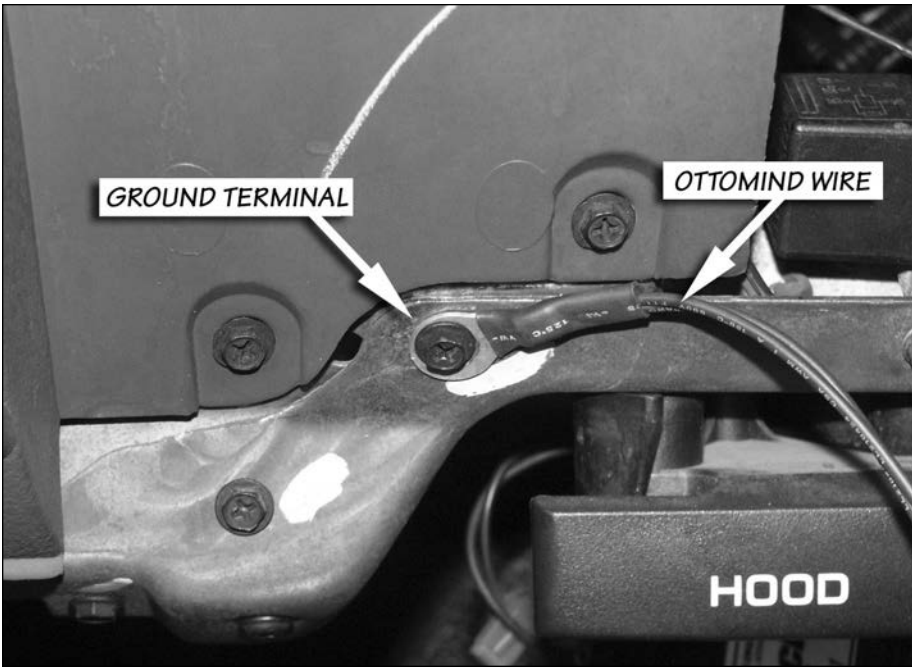
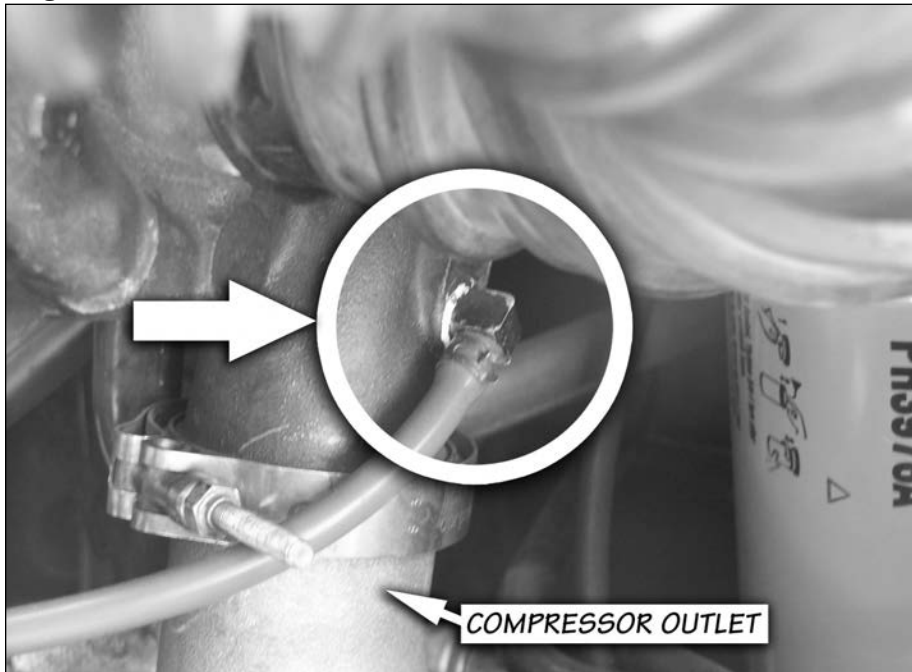

Figure 7



BOOST MODIFIER INSTALLATION

16. Find the actuator boost reference hose and locate the brass fitting on the compressor housing. See **Figure 7**.

17. Remove the hose clamp and detach the hose from the brass fitting. Save the clamp for re-installation.

18. Unscrew and remove the brass fitting. Install the supplied “boost modifier” in its place. Re-attach the actuator boost reference hose and securely clamp the hose with the original clamp.

NOTE: do not over tighten the fitting or damage to the threads might occur.

Section 2

CHECKING ENGINE PERFORMANCE

*NOTE: This verification of proper performance should be performed prior to permanent mounting of the Big Hoss Diesel Tuner as illustrated in **Steps 19-21**.*

Go over the entire installation as a precautionary check to ensure that all clamps are tight, wiring and hoses are properly routed, and connections are tight. Make sure that the wire harness is not laying in the way of the brake and gas pedals. Re-connect the battery terminals. Start the engine and allow it to warm up. Drive the vehicle under light load (normal around-town driving) for 20 to 30 minutes, and listen for any exhaust leaks or rattles, or intake boost leaks. Shut off the engine and re-tighten all intercooler and turbocharger boost clamps. These connections may have loosened with time, and if leaking, will cause a drop in boost pressure with a loss in performance. Check that clamps are properly positioned on hoses, and periodically check tightness of hose clamps at regular maintenance intervals, such as when the oil is changed.

Observe the operation of the boost and pyrometer gauges (if equipped) while driving under varying conditions. Turbocharger boost pressure will increase as a function of load and engine RPM, thus the engine will produce little boost while cruising at light throttle, with maximum boost while climbing hills heavily loaded during acceleration. Note the boost level seen during hard acceleration with a given load. If performance seems to have deteriorated sometime in the future, the maximum boost figures may be compared to see if boost has dropped off. Lower boost may be caused by turbo ducting leaks, a malfunctioning wastegate or fuel injection pump, or dirty air filter.

Typical maximum boost pressure settings for the Dodge/Cummins diesel will vary considerably with stick or automatic transmission options, year model of vehicle and altitude.

Use your pyrometer gauge (if equipped) to monitor exhaust gas temperature (EGT) in the engine. At idle, exhaust gas temperature will be very low, perhaps only 300°F. As the engine is accelerated for higher speeds with greater loads, the EGT will rise. The highest EGT will be seen under maximum load at full throttle, such as climbing a steep grade with a heavily laden vehicle. Your pyrometer is color coded to assist in your reading of the gauge. The red zone indicates a dangerous level of temperature. Your engine should not operate in this range for more than a few seconds. The blue zone indicates when it is safe to shut the engine off. To avoid heat damage to various engine components it is recommended that the exhaust gases cool below 400° before the engine is shut down.

The maximum recommended turbine inlet EGT (in the exhaust manifold) is 1300° F. Use caution to avoid exceeding 1300°.

If you feel that your Big Hoss Diesel Tuner is not functioning properly, some diagnostics can be performed. Your Big Hoss is equipped with diagnostic features that will detect and display certain errors. Turn vehicle key to ON position. Observe the two LEDs mounted on the upper corners of the black connector on the end of the Big Hoss. If all wire connections are correct, a steady green light is illuminated.

If a connection is incorrect or if there is a problem with the system, when the key is ON the LEDs will flash in sequence to identify a diagnostic code.

A Big Hoss Diesel Tuner’s diagnostic code is comprised of 2 digits. Each code is expressed in a sequence of 2 sets of the flashing red LED separated by a brief flashing of the green LED in between. Each set of a number of red LED flashes represents a digit. A longer flashing of the green LED separates the sequences. The LEDs will continue to flash to display all the errors, and then repeat. **Table 1** lists some common diagnostic codes.

For example, if an open EGT thermocouple is detected (code 2-3) by the Big Hoss, the following red and green LED flashing sequence is observed when the key is on:

- (1) Two times flashing RED LED
- (2) One time quick flashing GREEN LED
- (3) Three times flashing RED LED
- (4) One time longer flashing GREEN LED

The above flashing sequence will repeat continuously. When the problem is corrected, the diagnostic code will be eliminated and replaced by a steady green light. If problem persists, contact Banks Technical Service.

Table 1: Banks Big Hoss® Diagnostic Codes

Diagnostic Code	Code Description	Course of Action
1-2	Faulty MAP signal	Check MAP connection
2-2	Faulty MAP signal	Check MAP connection and call Banks Technical Service
2-3	Open EGT thermocouple	Check EGT thermocouple connection
2-4	Transmission torque converter	Check torque converter connection
3-3	Big Hoss internal error	Call Banks Technical Service
3-4	Communication Error	Check CAN Bus connection

Section 3

BIG HOSS MOUNTING

19. After confirming the functionality of the system, make sure all the mounting surface is clean and free of dirt and oil before mounting the Big Hoss. Clean and dry as required using a cloth dampened with rubbing alcohol or similar cleaning solution.

CAUTION: Do not spray fluid directly onto any electrical equipment, or equipment damage may result.

Mount the Big Hoss Diesel Tuner on the back of the lower dash panel as shown in **Figure 8** by peeling off the protective backing off the adhesive tape on the back of the Big Hoss Diesel Tuner box.

NOTE: The Big Hoss Diesel Tuner may not clear the steering structure if it mounted differently.

20. Hold the module against the panel for approximately 1 minute while applying pressure to allow the adhesive to properly adhere to the surface.

21. Re-install the lower dash panel with the original 3 bolts. Route all wiring away from any pedals or other moving components. Using the cable ties supplied, secure the wiring under the dash. Reinstall the trim panel. Secure all wiring under the hood away from heat sources or sharp edges. Your Banks product installation is complete.

Figure 8



Gale Banks Engineering
546 Duggan Avenue • Azusa, CA 91702
(626) 969-9600 • Fax (626) 334-1743

Product Information & Sales: (888) 635-4565
Customer Support: (888) 839-5600
Installation Support: (888) 839-2700

bankspower.com