

Owner's Manual with Installation Instructions

Banks Ram-Air[®] Intake System

2011-2014 Ford F150 5.0L Trucks

THIS MANUAL IS FOR USE WITH KIT 41880 & 41880-D

Gale Banks Engineering
546 Duggan Avenue • Azusa, CA 91702
(626) 969-9600 • Fax (626) 334-1743

Product Information & Sales: (888) 635-4565
Customer Support: (888) 839-5600
Installation Support: (888) 839-2700

bankspower.com



General Installation Practices

Dear Customer,

If you have any questions concerning the installation of your Banks Ram-Air System, please call our Technical Service Hotline at (888) 839-2700 between 7:00 am and 4:00 pm (PT). If you have any questions relating to shipping or billing, please contact our Customer Service Department at (888) 839-5600.

Thank you.

1. For ease of installation of your Banks Ram-air intake system, familiarize yourself with the procedure by reading the entire manual before starting work. This manual contains 16 pages of copy, illustrations and parts listing. If any pages are missing from this manual please call Gale Banks Engineering immediately for a replacement.
2. The exploded view of the Ram-Air assembly (pages 4-5) provides only general guidance. Refer to each step and section diagram in this manual for proper instruction.
3. Throughout this manual, the left side of the vehicle refers to the driver's side, and the right-side to the passenger's side.
4. Disconnect the ground cable from the battery before beginning work. If there are two batteries, disconnect both.

5. Route and tie wires and hoses a minimum of 6 inches away from exhaust heat, moving parts and sharp edges. Clearance of 8 inches or more is recommended where possible.

6. During installation, keep the work area clean. If foreign debris is transferred to any Banks system component, clean it thoroughly before installing.

7. When raising the vehicle, support it on properly weight-rated safety stands, ramps or a commercial hoist. Follow the manufacturer's safety precautions. Take care to balance the vehicle to prevent it from slipping or falling. When using ramps, be sure the front wheels are centered squarely on the topsides; put the transmission in park; set the parking brake; and place blocks behind the rear wheels.

Definitions of ANSI Z535 Safety Standards

⚠ DANGER: Indicate[s] a hazardous situation which, if not avoided, **will result in death or serious injury.**

⚠ WARNING: Indicate[s] a hazardous situation which, if not avoided, **could result in death or serious injury.**

⚠ CAUTION: Indicate[s] a hazardous situation which, if not avoided, **could result in mild or moderate injury.**

NOTICE: Indicate[s] a situation that requires your immediate attention.

⚠ CAUTION: Do not use floor jacks to support the vehicle while working under it. Do not raise the vehicle onto concrete blocks, masonry or any other item not intended specifically for this use.

NOTICE: The Banks Oiled Ram-Air Filter comes pre-oiled and no oiling is necessary for initial installation. Service the filter as specified in the Ram-Air Filter Cleaning Instructions Section of this manual.

Tools Required:

- Hex driver for use with supplied T20 Torx Bit
- $\frac{3}{8}$ " Drive ratchets with metric and standard sockets
- Standard and Phillips head screwdrivers
- Stubby Phillips head screwdriver
- Standard and needle-nose pliers
- Clean shop towels or rags
- $\frac{5}{16}$ " Nut driver

Table of Contents

Section 1	4
General Assembly	
Section 2	6
Ram-Air Installation	
Section 3	
Oiled Air Filter Cleaning Instructions . .	13
Dry Air Filter Cleaning Instructions . . .	14
Section 4	15
Logo Placement	

Section 1

GENERAL ASSEMBLY

Figure 1

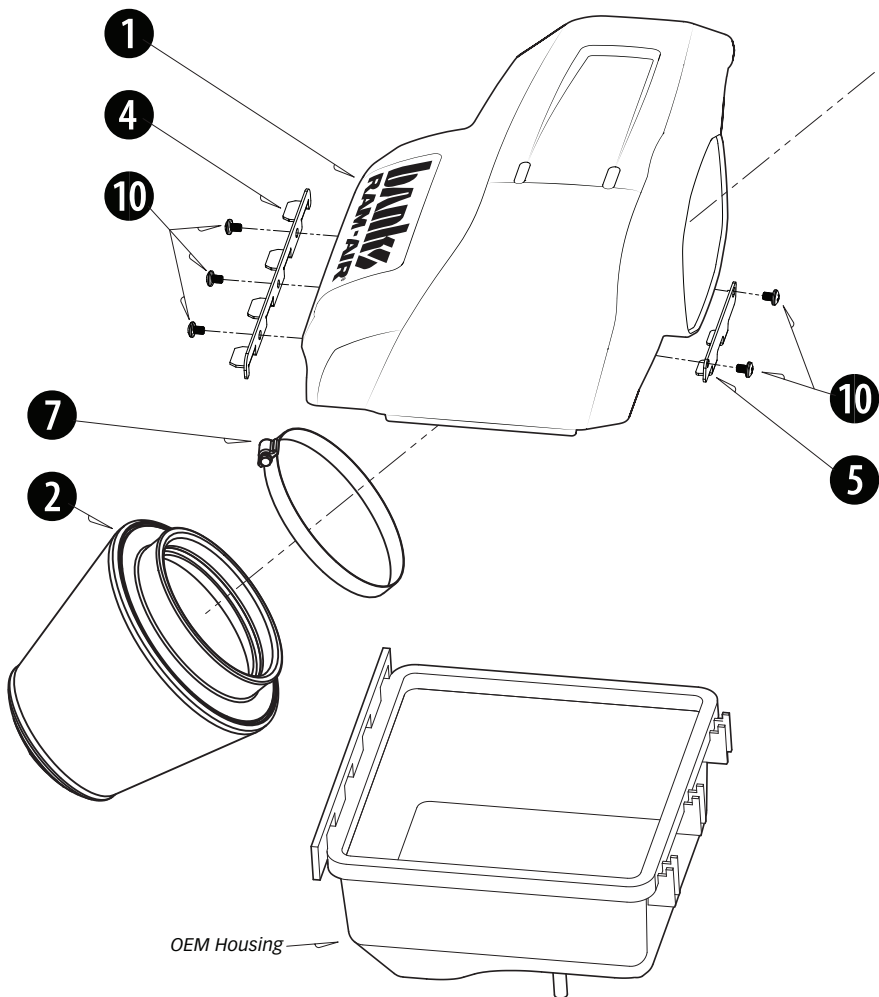

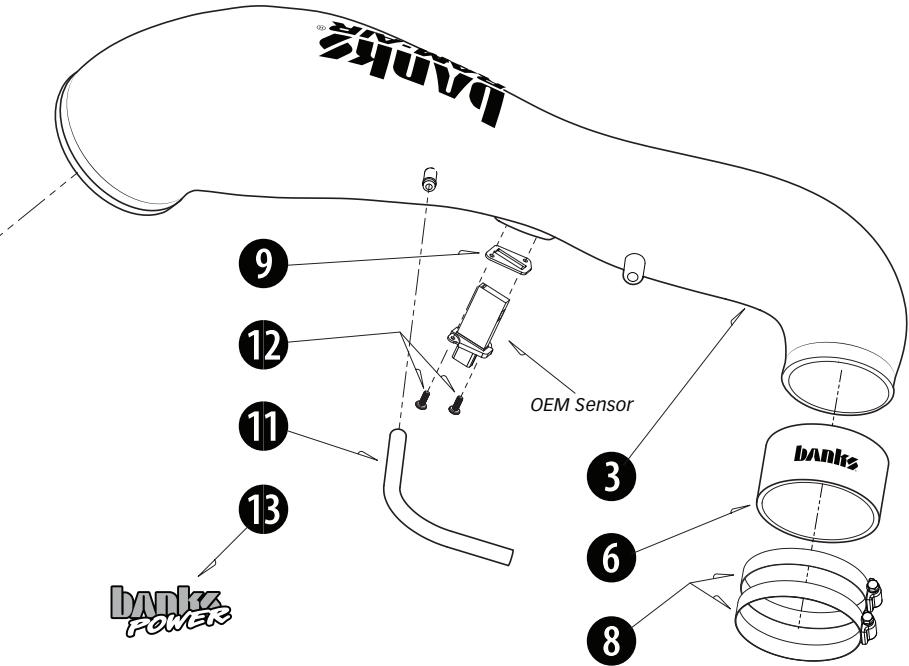

Item #	Description	Part #	QTY
1	Lid, Ram-Air Housing	41871	1
2	Air Filter Element, Ram-Air System	41828	1
3	Intake Tube, Ram-Air System	41877	1
4	Lid Mounting Bracket, Left	41873	1
5	Lid Mounting Bracket, Right	41874	1
6	Hose, 3.5" X 2.0", Black - Techni-Cooler, Various Apps	94211	1
7	Hose Clamp, #104	92904	1
8	Hose Clamp, #56	92857	2
9	MAF gasket	93067	1
10	Machine Screw Pan head-phil, M6-1.0 x 8mm S/S	91248	5
11	Hose, PCV, 3/8"Id X 1/2"Od - Bulk	94136	1
12	Screw, Truss Head, Phillips, 6-32 x 1/2", SS	91719	2
13	Urocal, Banks Power, Small	96009	2

Section 2

RAM-AIR INSTALLATION

NOTICE: Use the Bill of Materials Chart and the General Assembly Drawing to reference component nomenclature and location. Use caution when working in the engine compartment. Make sure the engine has been OFF for several hours and cool.

You are about to install the Banks Ram-Air Intake System. Read and follow all steps before working on the vehicle. Some components from the OEM air intake system will remain in service. Take care when removing OEM air intake components to not damage them.

1. Disconnect the MAF Sensor connector. See **Figure 2**.
2. Use the provided Torx20 bit (92987) to remove the two MAF Sensor screws. See **Figure 3**.
3. Completely remove the OEM MAF Sensor. See **Figure 4**.

4. Disconnect the OEM 5/8" Hose. See **Figure 5**.
5. Disconnect the PCV Hose near the throttle body by pushing on the grey tab and pulling outward. See **Figure 6**.
6. Loosen the throttle body clamp of the OEM Intake Tube using a 5/16" nut driver. See **Figure 7**.
7. Un-latch the 3 clips holding the OEM Lid to the Air Filter Housing. See **Figure 8**.
8. Remove the OEM Lid, Tube and Filter from the Air Filter Housing. See **Figure 9**.
9. Locate Banks Ram-Air Filter Lid (41871), and left Mounting Bracket (41873). Attach the lid support brackets to Banks Ram-Air Filter Lid using supplied M6 Phillips Head machine screws (91248) . See **Figure 10**.

Figure 2

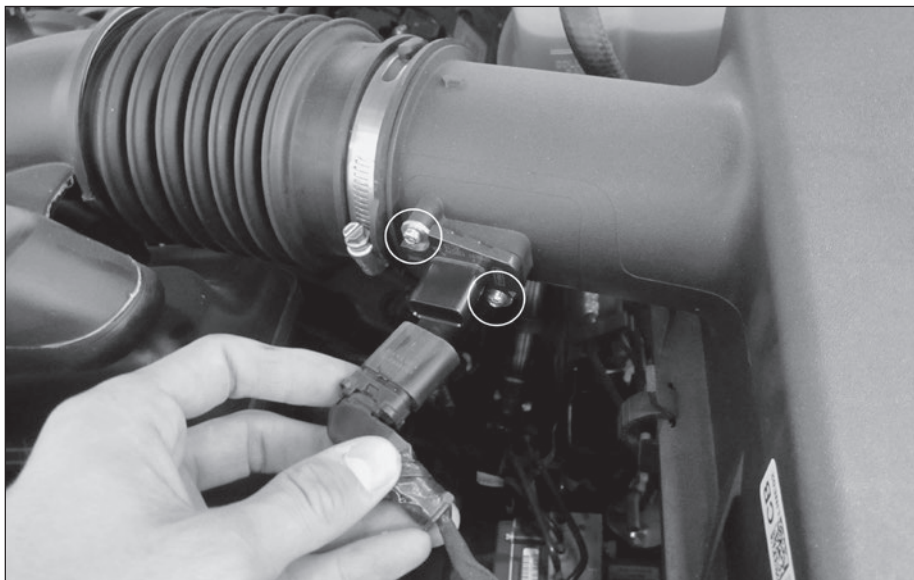

Figure 3

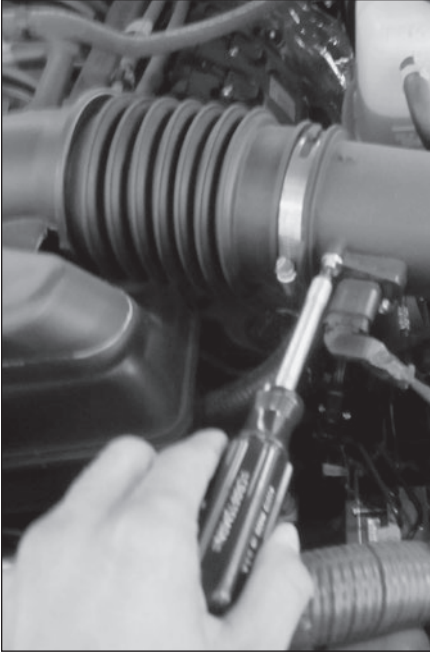

Figure 4

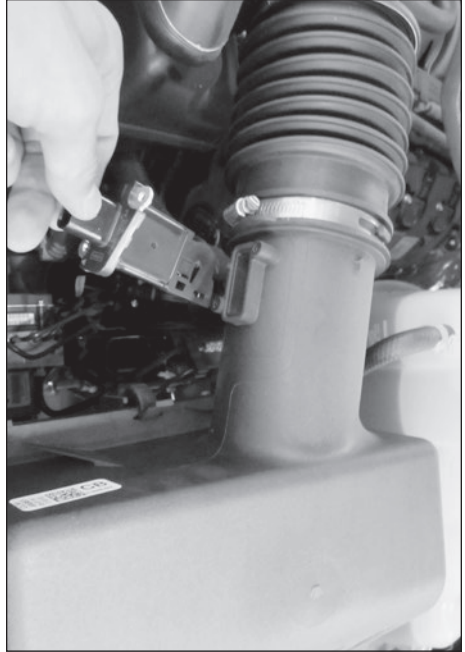

Figure 5

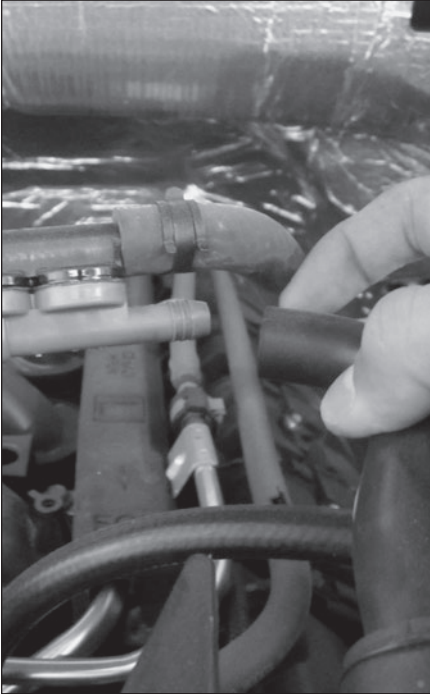

Figure 6

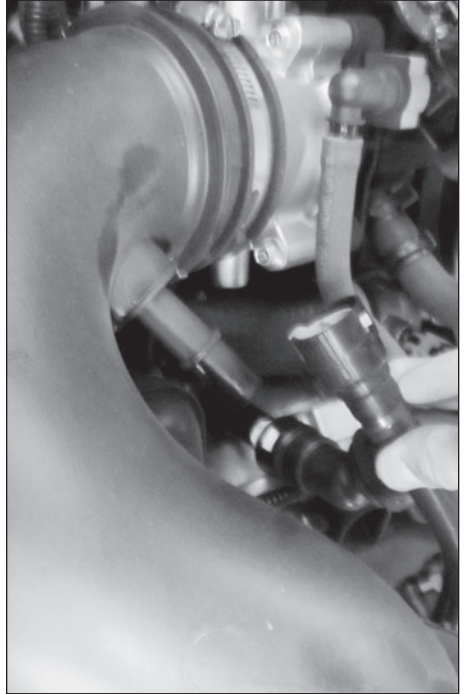

Figure 7

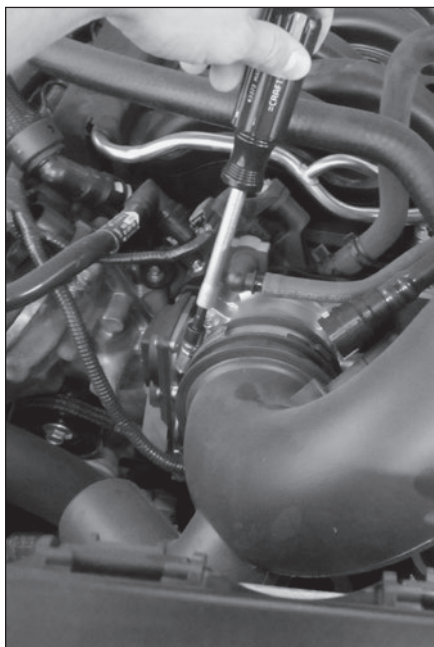

Figure 8

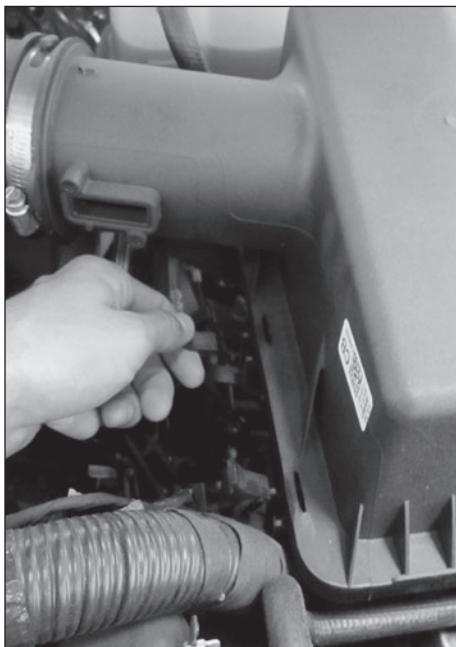

Figure 9

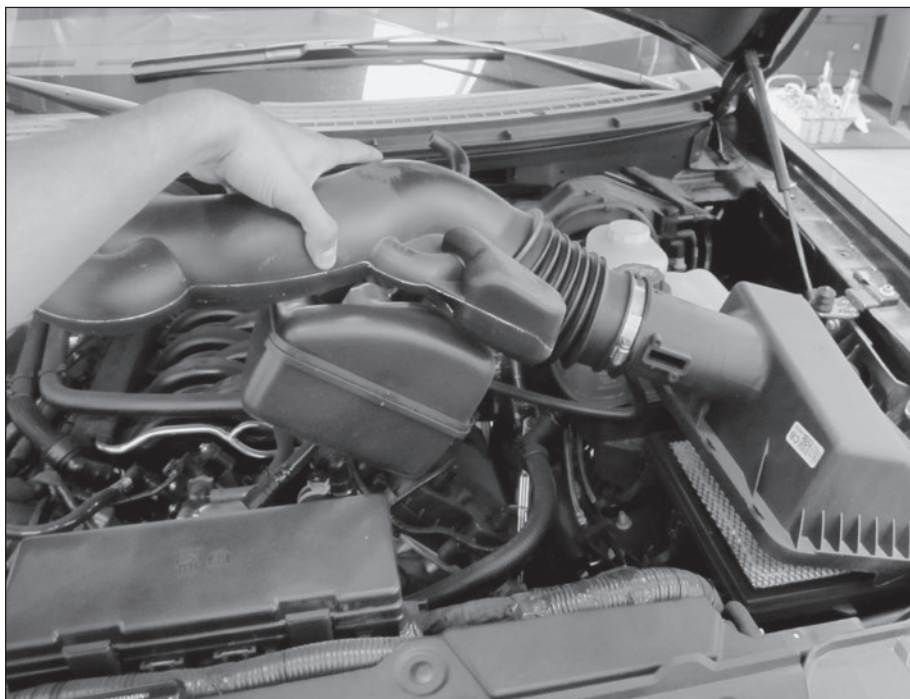

Figure 10

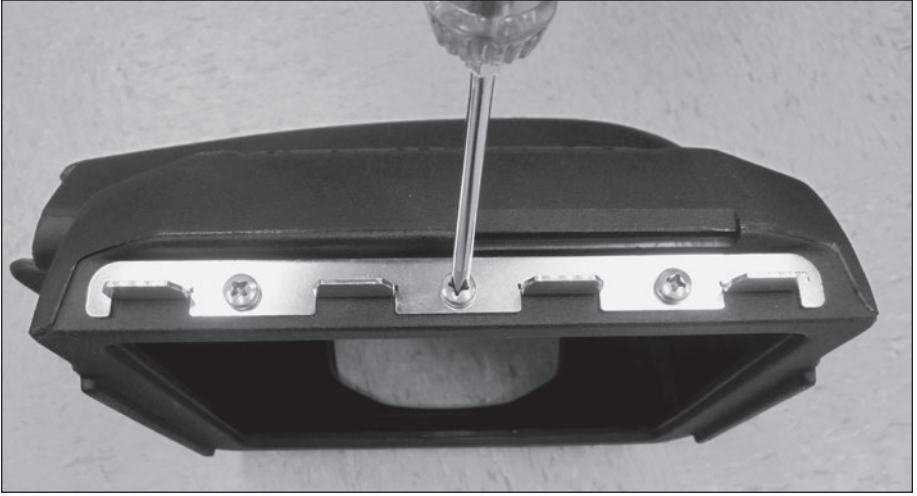

Figure 11

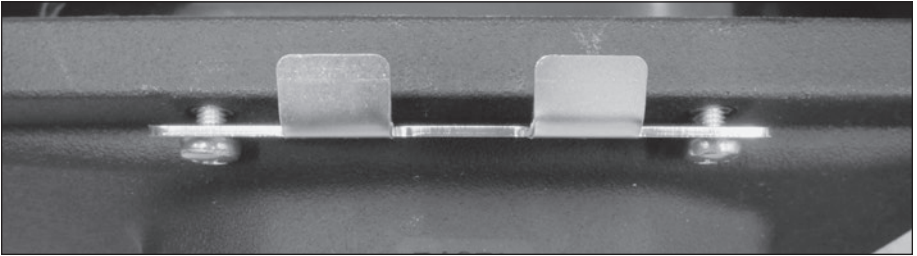
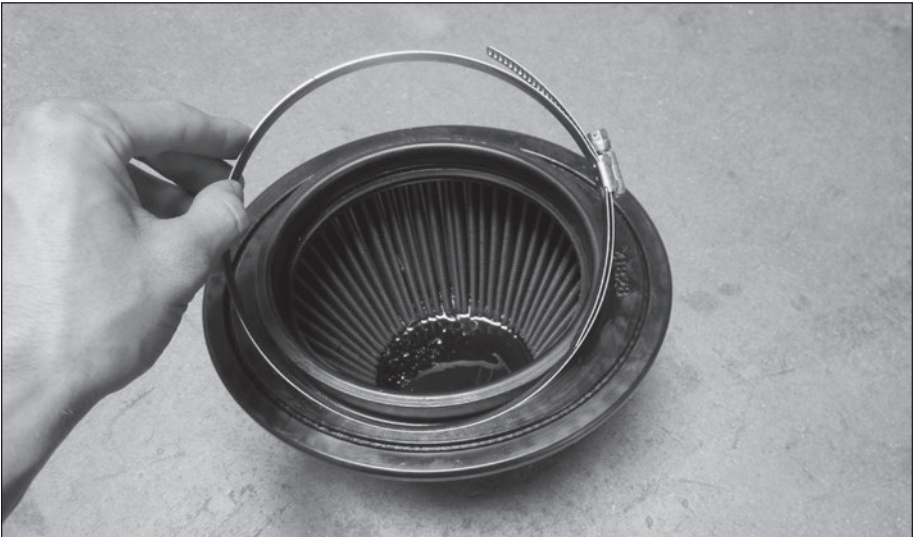

Figure 12



10. Install the Right Mounting Bracket (41874) onto the lid. Very loosely install the bracket using supplied M6 Phillips Head machine screws (91248).

NOTICE: This item will be fully tightened down at a later step. See **Figure 11**.

11. Install the Hose Clamp #104 (92904) onto the Filter (41828) and loosely tighten. See **Figure 12**.

12. Insert large opening of Banks Intake Tube (41877), into corresponding opening in Banks Housing lid. Insert the tube far enough to be able to install Banks Ram-Air Filter onto Intake Tube. See **Figure 13**.

13. When installing Banks Air Filter onto Banks Intake Tube you will feel a snap as the filter fully seats onto intake tube. Tighten band clamp with a 5/16" nut driver. See **Figure 14**.

14. Install the 3/8" Hose (94136) onto the Banks Tube. Use a twisting motion and make sure the Hose is close to

bottoming out on the Tube. See **Figure 15**.

15. Remove the OEM gasket from the MAF Sensor and install the Banks MAF Gasket (93067) onto the OEM sensor. See **Figure 16**.

16. Install OEM MAF Sensor into the Banks Tube (41878) using the two provided 6-32 screws (91719). See **Figure 17**.

17. Install the 94211 Silicone Hose and two 92857 #56 Hose clamps onto the OEM Throttle Box Inlet. Do not tighten down the clamps at this step. See **Figure 18**.

18. Insert Banks Tube, Lid and Filter assembly onto OEM Airbox Housing. The assembly should be inserting in the angle shown in the picture for easiest installation. Ensure that tabs of the brackets fit into the slots of the OEM housing and the Banks Lid is flat against the OEM Housing. See **Figure 19**.

Figure 13

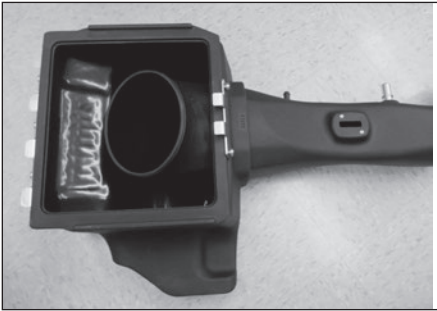

Figure 14



Figure 15

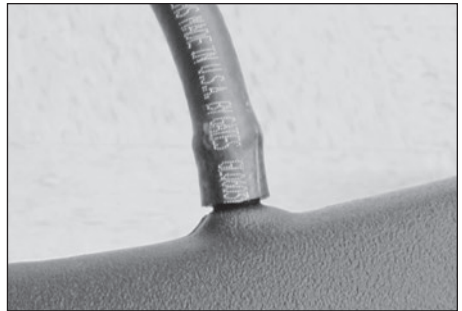

Figure 16

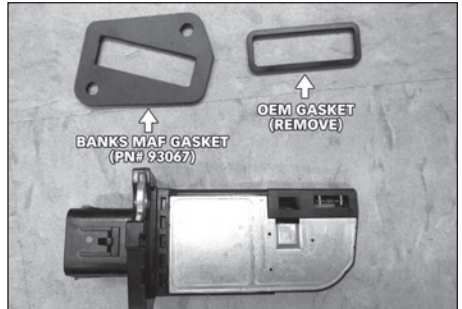

Figure 17



Figure 19b



Figure 18

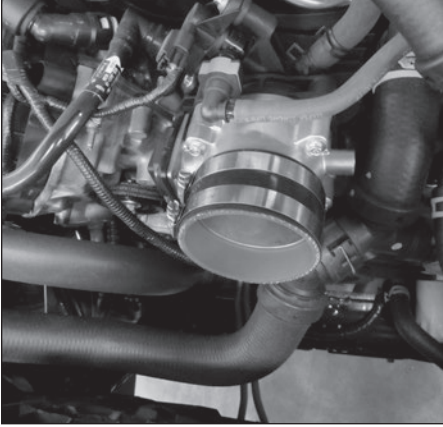

Figure 20

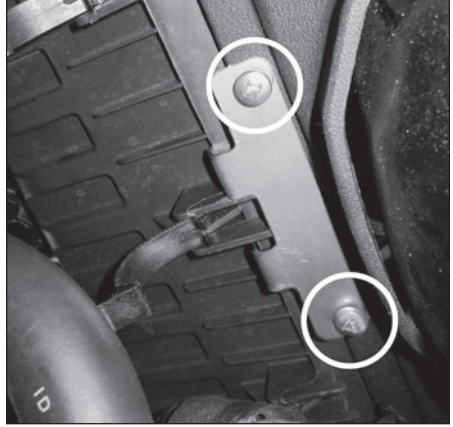

Figure 19a

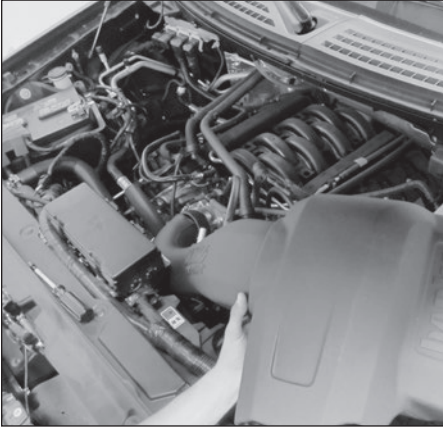

Figure 21



NOTICE: Variation in the OEM Airbox Housing may make installation of the right Mounting Bracket into the corresponding feature of the OEM Airbox Housing difficult. If this is the case on your vehicle, completely remove the right Mounting Bracket and reinstall once the Banks Tube, Lid and Filter assembly is completely seated in the OEM Airbox Housing

19. Insert the Banks Tube into the Silicon Hose Coupling and tighten down the two hose clamps using a 5/16" nut driver.

Figure 22

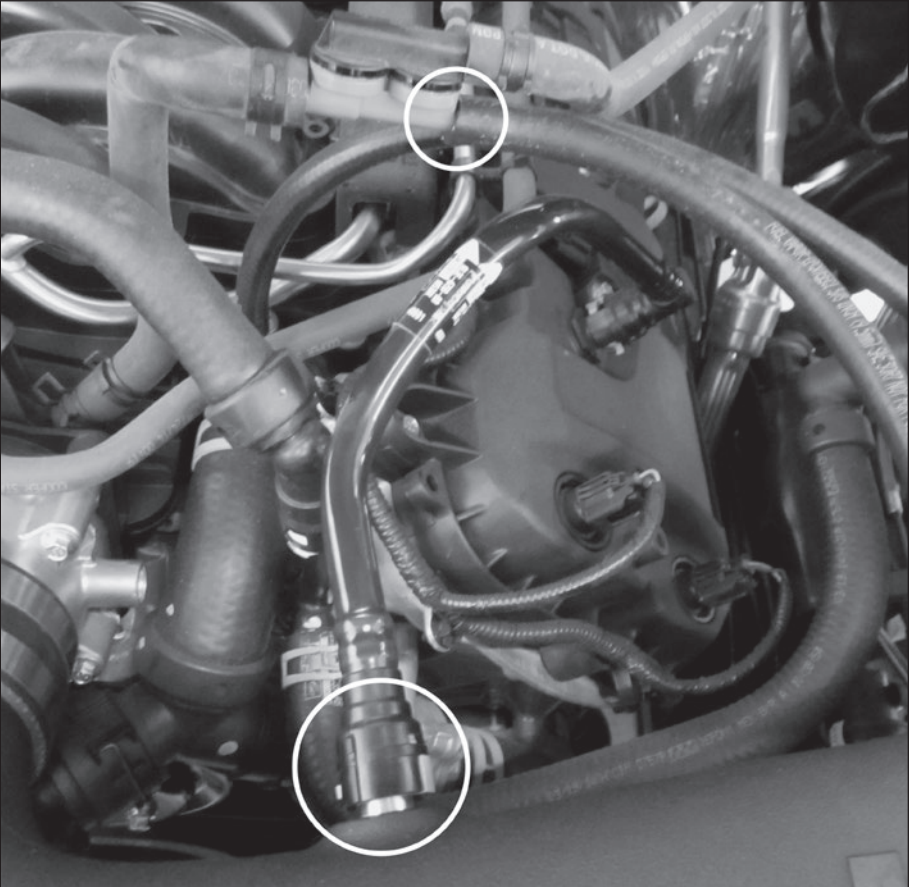

20. Fully install the right side housing bracket and tighten down the screws. See **Figure 20**.

NOTICE: A stubby Phillips head screwdriver is required for the front screw.

OPTIONAL: The OEM latching tabs can be removed or positioned out of the way of the new bracket and left on the housing.

21. Insert the MAF Sensor Connector onto the OEM MAF Sensor and push in

the red tab to secure it. See **Figure 21**.

22. Install the OEM PCV port onto the Banks tube and orient the line to avoid it being kinked. Install the 3/8" hose onto the OEM Check Valve Port. See **Figure 22**.

This completes the installation of the Banks Ram-Air Intake system. Check all hose clamps for tightness and connectors for a sure fit and intake tube is not touching any engine components.

-END, SECTION 2-

Section 3

AIR FILTER CLEANING INSTRUCTIONS

OILED AIR FILTER ONLY

NOTICE: The Banks Ram-Air Oiled Air Filter comes pre-oiled and no oiling is necessary for initial installation. Use Banks Ram-Air Filter Cleaning System (part#90094), available from Gale Banks Engineering to service the Air Filter. Follow the instructions included with the cleaning system to clean and re-oil your Bank Ram-Air Oiled Air Filter.

1. PRE-CLEANING

Tap the element to dislodge any large embedded dirt, then gently brush with a soft bristle brush. *NOTE: If complete cleaning is not practical at this time, reoil the element and reinstall in your vehicle.*

2. SPRAY-ON CLEANING

Spray air-filter cleaner liberally onto the entire element and let soak for 10 minutes.

3. PAN CLEANING

Large air-filter elements can be rolled or soaked in a shallow pan of air-filter cleaner. Remove immediately and let soak for approximately 10

minutes.

NOTICE: NEVER use gasoline, steam, caustic solutions, strong detergents, high-pressure nozzles, or cleaning solvents to clean the filter element. All of these can cause harm to the filter media as well as SHRINK and HARDEN the rubber end caps.

4. RINSING

Rinse off the element with low-pressure water. Tap water is okay. Always flush from the clean side to dirty side. This removes the dirt and does not drive it into the filter.

5. DRYING

Always dry naturally. After rinsing, shake off all excess water and let the element dry naturally.

6. AEROSOL OILING

After cleaning air filter always reoil before using. Spray air filter oil down into each pleat with one pass per pleat. Wait 10 minutes and re-oil any white spots still showing.

7. OILING HINTS

Never use a Banks Ram-Air filter without oil (the filter will not stop

the dirt without the oil). Use only air filter oil. Air-filter oil is a compound of mineral and animal oil blended with special polymers to form a very efficient tack barrier. Red dye is added to show just where you have applied the oil. Eventually the red color will fade but the oil will remain and filter the air. NEVER USE Automatic Transmission Fluid. NEVER USE Motor Oil. NEVER USE Diesel Fuel. NEVER USE WD40, LPS, or other light-weight oils.

8. REINSTALL

Reinstall your Banks Ram-Air filter element with proper care. Make sure the element seats properly in the filter case. Install the cover making sure it's in the right position. Tighten all the nuts, bolts, screws or clips to factory specifications.

9. DO NOT DISCARD

Affix the "Do Not Discard" sticker to the filter case (included with every Banks replacement element). Make sure you put the sticker in a highly visible place to alert your mechanic not to discard.

10. PERFORMANCE HINTS

Service every 50-100,000 miles on street-driven applications. Service more often in offroad or heavy-dust conditions. If an air-filter restriction gauge is installed, then change the element when the air-filter restriction reaches 18"—H.O.

⚠ CAUTION: Extremely fine dust from agriculture or offroad use will pull the oil from the element. Frequent reoiling of the element's clean side might be required. Completely service when practicable. For extra protection use an air-filter sealing grease on rubber ends of the element. Service only with air-filter cleaner and air-filter oil.

DRY FILTER CLEANING

Clean every 50-100,000 miles on street-driven applications. Clean more often in offroad or heavy-dust conditions. If an air-filter restriction gauge is installed, then change the element when the air-filter restriction reaches 18"—H.O.

1. PRE-CLEANING

Carefully tap the air filter element to dislodge any large embedded dirt or debris.

2. CLEANING

Spray an appropriate DRY AIR-FILTER CLEANER SOLUTION liberally onto both sides of the entire filter element with the majority applied to the dirty side. Soak for 10 minutes. Do not allow the DRY AIR-FILTER CLEANER SOLUTION to dry on the air filter.

NOTICE: NEVER use gasoline, steam, caustic solutions, strong detergents, high-pressure nozzles, or cleaning solvents to clean the filter element. All of these can cause harm to the filter media as well as SHRINK and HARDEN the rubber end caps.

3. RINSING

Rinse the filter element with cool or warm (not hot) water from the clean side out in order to flush the dirt out of the filter. It may be necessary to use your fingers on the hose to apply light water pressure. Repeat steps 2 and 3, until the water flowing through the media is completely clear of any dirt and debris.

4. DRYING

After rinsing, gently shake off excessive water and allow to dry naturally. Re-install the filter onto the intake system, airbox or custom assembly once it is dry or just slightly damp. Follow all original installation instructions.

5. REINSTALL

Reinstall your Banks Ram-Air filter element with proper care. Make sure the element seats properly in the filter case. Install the cover making sure it's in the right position. Tighten all the nuts, bolts, screws or clips to factory specifications.

6. DO NOT DISCARD

Affix the "Do Not Discard" sticker to the filter case (included with every Banks replacement element). Make sure you put the sticker in a highly visible place to alert your mechanic not to discard.

7. PERFORMANCE HINTS

Service every 50-100,000 miles on street-driven applications. Service more often in offroad or heavy-dust conditions. If an air-filter restriction gauge is installed, then change the element when the air-filter restriction reaches 18"-H.O.

-END, SECTION 3-

Section 4

PROPER LOGO PLACEMENT

Your system includes two Banks Power logos that have been designed to compliment the Ford badging on your truck. We have provided measurements, which will allow you to place these logos in a position that gives a clean OEM look.

See **Figure 26**.

-END, SECTION 4-

Figure 26

TYPICAL LEFT FENDER



TYPICAL RIGHT FENDER



Gale Banks Engineering
546 Duggan Avenue • Azusa, CA 91702
(626) 969-9600 • Fax (626) 334-1743

Product Information & Sales: (888) 635-4565
Customer Support: (888) 839-5600
Installation Support: (888) 839-2700
www.bankspower.com