

# Owner's Manual with Installation Instructions

## Banks Ram-Air<sup>®</sup> Intake System

**2015-2016 Ford F150 2.7L & 3.5L  
Eco-Boost Trucks**

THIS MANUAL IS FOR USE WITH KIT 41884, 41884-D

Gale Banks Engineering  
546 Duggan Avenue • Azusa, CA 91702  
(626) 969-9600 • Fax (626) 334-1743

Product Information & Sales: (888) 635-4565  
Customer Support: (888) 839-5600  
Installation Support: (888) 839-2700

**[bankspower.com](http://bankspower.com)**



# General Installation Practices

Dear Customer,

If you have any questions concerning the installation of your Banks Ram-Air System, please call our Technical Service Hotline at (888) 839-2700 between 7:00 am and 4:00 pm (PT). If you have any questions relating to shipping or billing, please contact our Customer Service Department at (888) 839-5600.

Thank you.

1. For ease of installation of your Banks Ram-air intake system, familiarize yourself with the procedure by reading the entire manual before starting work. This manual contains 16 pages of copy, illustrations and parts listing. If any pages are missing from this manual please call Gale Banks Engineering immediately for a replacement.
2. The exploded view of the Ram-Air assembly (pages 4-5) provides only general guidance. Refer to each step and section diagram in this manual for proper instruction.
3. Throughout this manual, the left side of the vehicle refers to the driver's side, and the right-side to the passenger's side.
4. Disconnect the ground cable from the battery before beginning work. If there are two batteries, disconnect both.

5. Route and tie wires and hoses a minimum of 6 inches away from exhaust heat, moving parts and sharp edges. Clearance of 8 inches or more is recommended where possible.

6. During installation, keep the work area clean. If foreign debris is transferred to any Banks system component, clean it thoroughly before installing.

7. When raising the vehicle, support it on properly weight-rated safety stands, ramps or a commercial hoist. Follow the manufacturer's safety precautions. Take care to balance the vehicle to prevent it from slipping or falling. When using ramps, be sure the front wheels are centered squarely on the topsides; put the transmission in park; set the parking brake; and place blocks behind the rear wheels.

## Definitions of ANSI Z535 Safety Standards

**⚠ DANGER:** Indicate[s] a hazardous situation which, if not avoided, **will result in death or serious injury.**

**⚠ WARNING:** Indicate[s] a hazardous situation which, if not avoided, **could result in death or serious injury.**

**⚠ CAUTION:** Indicate[s] a hazardous situation which, if not avoided, **could result in mild or moderate injury.**

**NOTICE:** Indicate[s] a situation that requires your immediate attention.

**⚠ CAUTION:** Do not use floor jacks to support the vehicle while working under it. Do not raise the vehicle onto concrete blocks, masonry or any other item not intended specifically for this use.

**NOTICE:** The Banks Ram-Air Filter comes pre-oiled and no oiling is necessary for the initial installation. Service the filter as specified in the Filter Maintenance Section of this manual.

## Tools Required:

- Flat and Phillips screwdriver
- 7mm and 8mm nut driver
- 13mm open or box-end wrench

## Table of Contents

<b>Section 1</b> .....	<b>4</b>
General Assembly	
<b>Section 2</b> .....	<b>6</b>
OEM Intake System Removal	
<b>Section 3</b> .....	<b>8</b>
Banks Ram-Air® Assembly	
<b>Section 4</b> .....	<b>12</b>
Filter Maintenance	
<b>Section 5</b> .....	<b>14</b>
Logo Placement	

# Section 1

## GENERAL ASSEMBLY

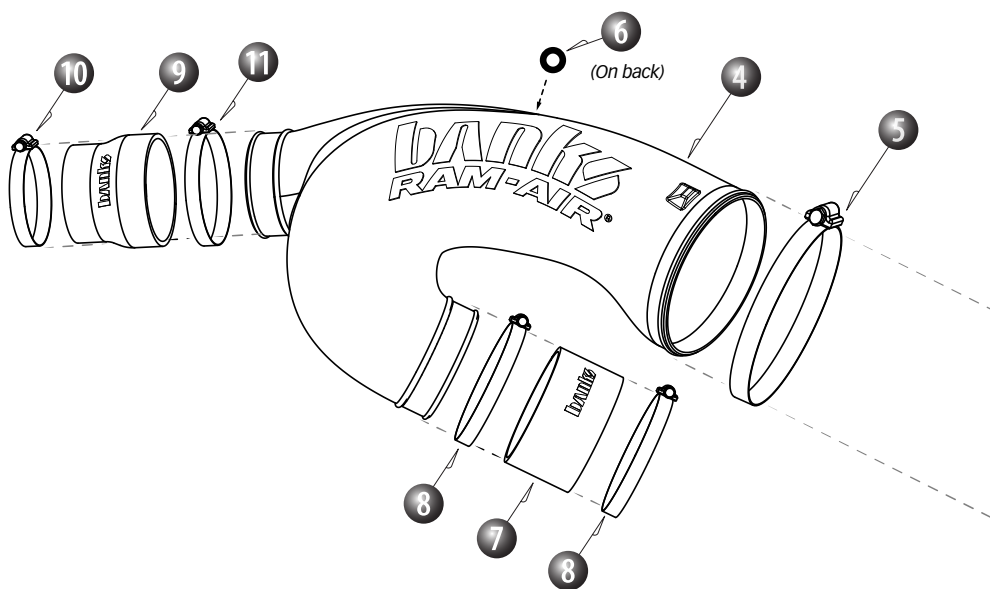

Item #	Description	Part #	QTY
1	Banks Ram-Air Housing	41886	1
2	Air Filter Element, Ram-Air System (Oiled or Dry)	41885/ 41885-D	1
3	Window, Banks Logo	41788	1
4	Intake Tube, Ram-Air System	41887	1
5	Hose Clamp, #104 - Air Filter Mount	92904	1
6	Grommet, Temp Sensor	93652	1
7	Hose, 4"	94317	1
8	Hose Clamp, #64	92864	2
9	Hose, 3.5" x 3.0" Reducer	94325	1
10	Hose Clamp, #52	92853	1
11	Hose Clamp, #56	92857	1
12	Machine Screw Truss HD Phil 1/4"-20 x 3/8" S/S	91128	4
13	Retainer, Push-Type, Black-11/16" Head x 1/4", Nylon 6	92020	2
14	Threadlocker, Blue	90001	1
15	Cable Tie, Black, 6"	62001	2
16	Banks Urocal	96009	2

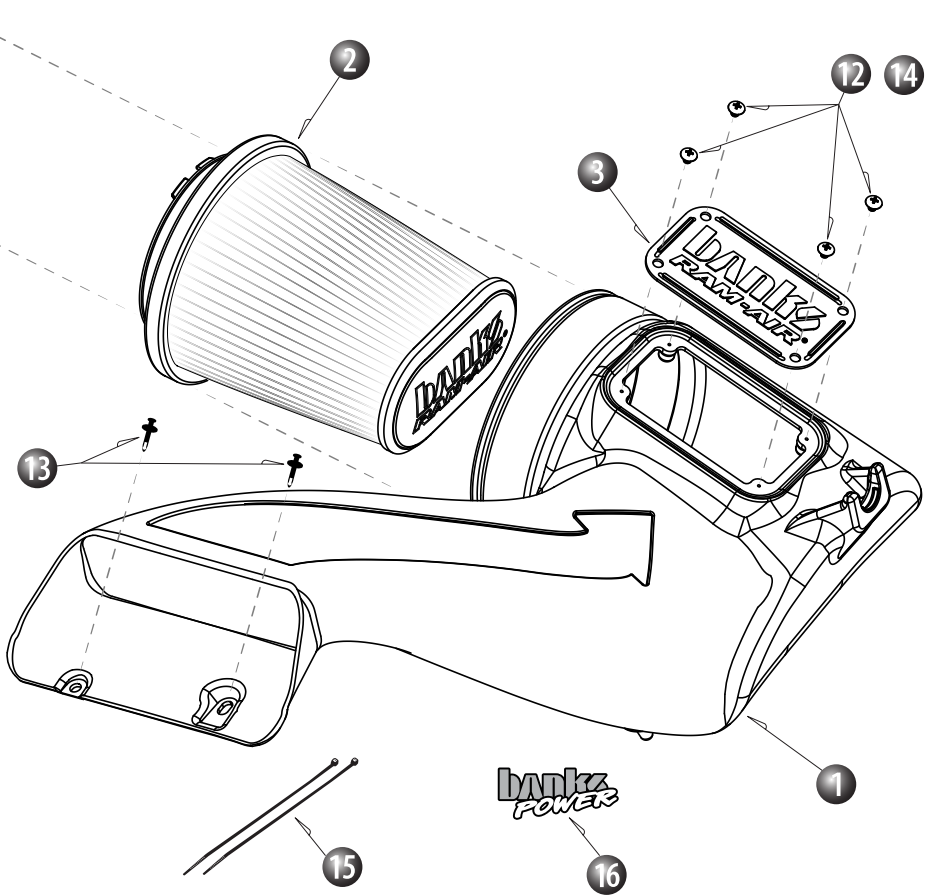

# Section 2

## OEM INTAKE SYSTEM REMOVAL

**NOTICE:** Use the Bill of Materials Chart and the General Assembly Drawing to reference component nomenclature and location. Use caution when working in the engine compartment. Make sure the engine has been OFF for several hours and cool.

You are about to install the Banks Ram-Air Intake System. Read and follow all steps before working on the vehicle. Some components from the OEM air intake system will remain in service. Take care when removing OEM air intake components to not damage them.

1. Unbolt the OEM airbox from the vehicle. See **Figure 1**.
2. Loosen the two band clamps on OEM intake tube at connection to OEM boost tubes. See **Figure 2**.
3. Remove the two harness clips from the airbox cover. See **Figure 3**.
4. Disconnect the intake air temp sensor connection from the OEM intake tube. See **Figure 4**.
5. Remove the two plastic push type retainer clips at the air duct entrance. See **Figure 5**.
6. Remove the OEM intake system. See **Figure 6**.

**Figure 1**

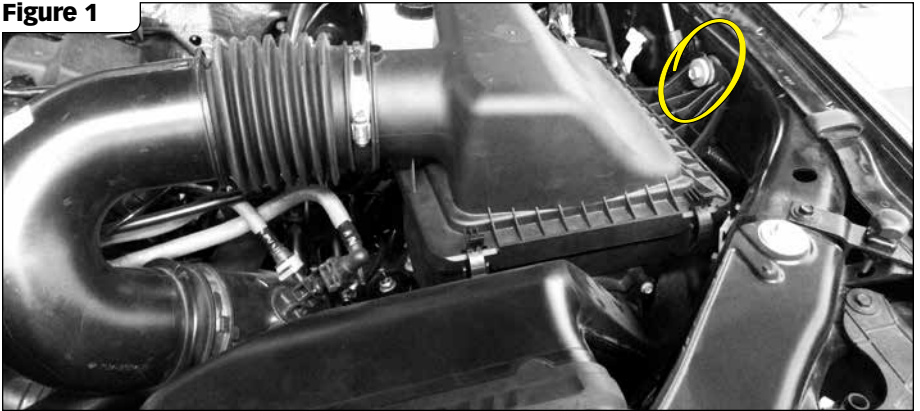

**Figure 2**

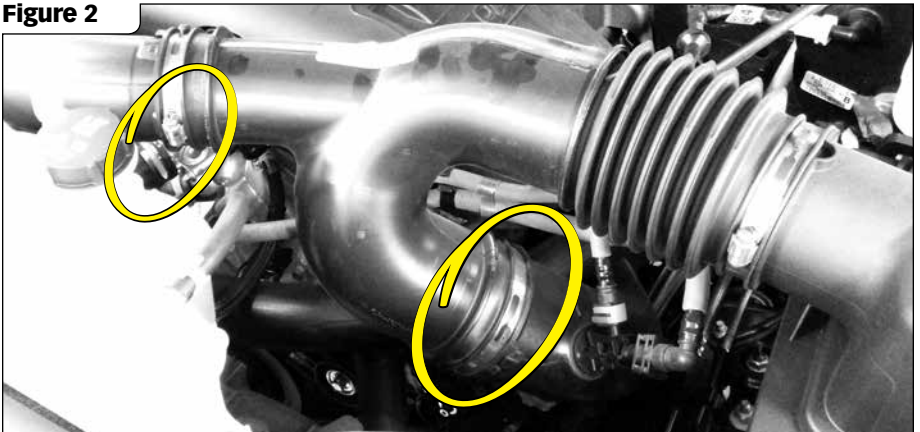

**Figure 3**

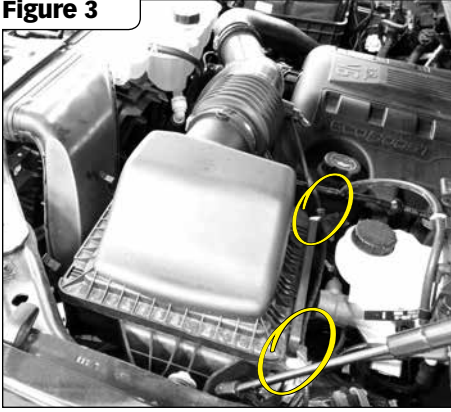

**Figure 4**

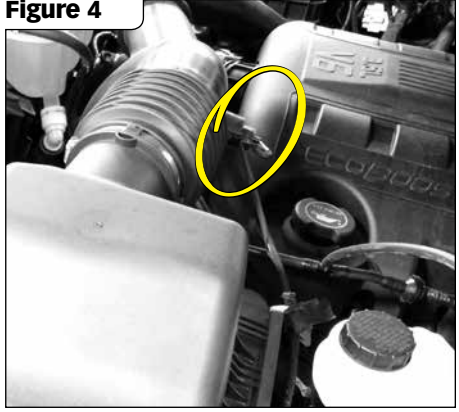

**Figure 5**

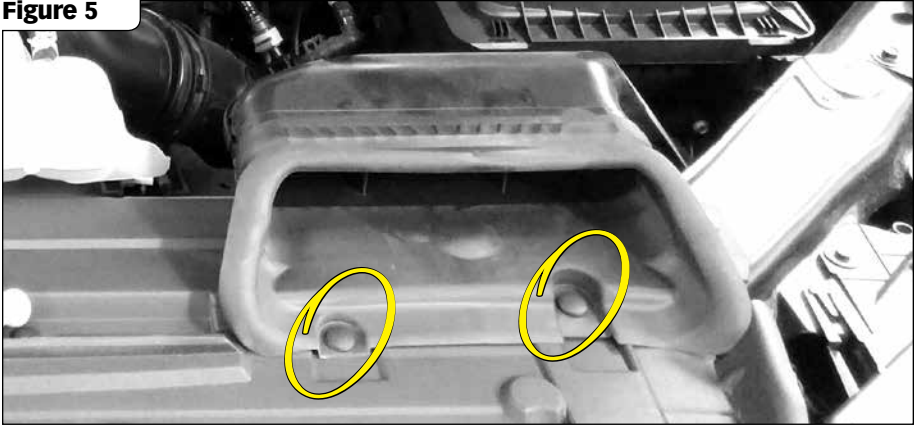

**Figure 6**



# Section 3

## BANKS RAM-AIR® ASSEMBLY

**1.** Insert the Temp Sensor Grommet into the hole on the side of the intake tube. See **Figure 7**.

**2.** Twist the air intake temp sensor counter-clockwise, and pull to remove the sensor from the OEM intake tube. See **Figure 8**.

**3.** Remove the O-ring on the air intake temp sensor. See **Figure 9**.

**4.** Insert the air intake temp sensor into the Temp Sensor Grommet. Align the tab on the air intake temp sensor to point to the intake tube inlet. See **Figure 10**.

**5.** Connect the filter to the intake tube, and align the key on the intake tube to the keyway at the air filter

base. Secure the filter to the intake tube using the supplied hose clamp. See **Figure 11**.

**6.** Attach the 2 hose couplers to the intake tube, and use the clamp #56 (pn#92857) on 3.5" hose end and clamp #64 (pn#94317) on the 4" hose end. See **Figure 12**.

**7.** Apply blue threadlocker to 4 supplied window screw and use to install clear window onto housing. Do not over tighten these screw. They just need to be snug. See **Figure 13**.

**Note:** Window screws may vibrate loose if threadlocker is not applied.

**Figure 7**



**Figure 8**

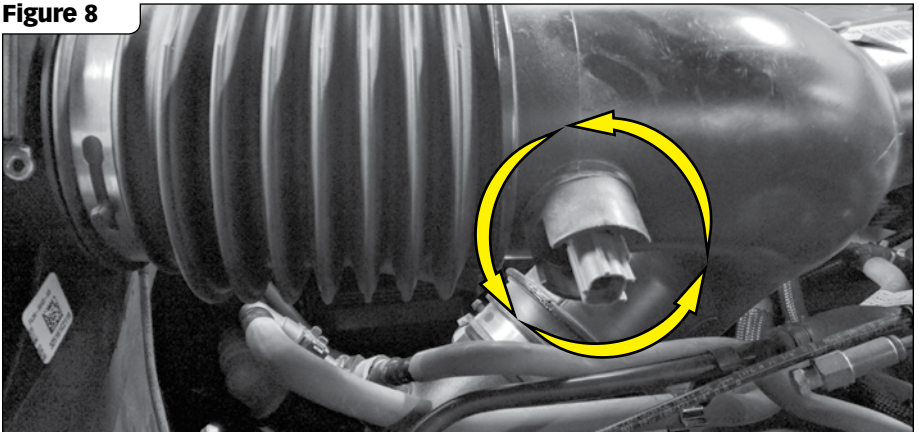



Figure 9

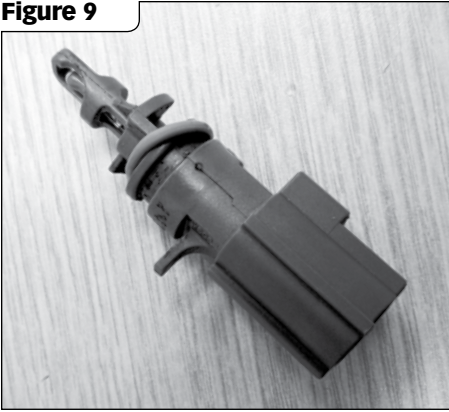

Figure 10

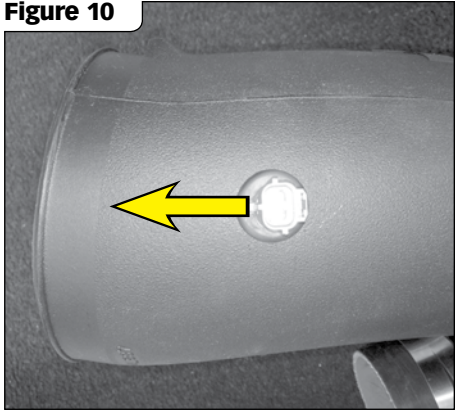

Figure 11

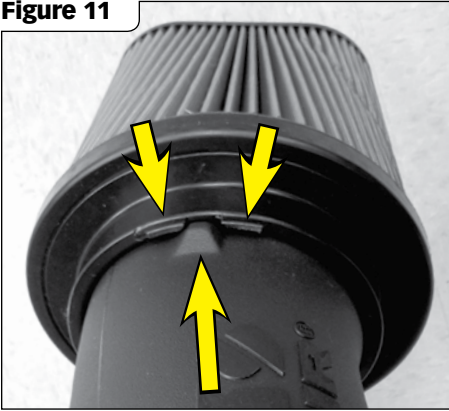

Figure 12



Figure 13



# Section 3

## BANKS RAM-AIR® ASSEMBLY (continued)

**8.** Insert the air filter at a slight angle and push the filter completely into the housing. See **Figure 14**.

**9.** Align the arrow at the filter base to the arrow on the housing. See **Figure 15**.

**10. For 2.7L engine ONLY,** disconnect front EVAP line on the throttle inlet tube. Reroute the line behind the rear EVAP hose, and reconnect. This is to ensure there is clearance from Ram-Air Intake Tube to the EVAP line. See **Figures 16 & 17**.

**11.** Install the intake assembly and connect the hose ends to the OEM intake tubes. Secure the 3" hose end first using the clamp #52, and the clamp #64 on the 4" hose end. Ensure the hoses are fully seated against the hose stoppers on the OEM intake tubes. See **Figure 18**.

**12.** Secure the housing duct using the 2 supplied plastic push-type retainers. See **Figure 19**.

**13.** Remove the steel sleeve and then

the rubber bushing from the OEM airbox lid. See **Figure 20**.

**14.** Bolt the rubber bushing and the steel sleeve with the original hardware. See **Figure 21**.

**15.** Connect the air intake temp sensor harness clip to the sensor. See **Figure 22**.

**16.** Zip tie the loose air intake temp sensor harness to the brake fluid level sensor harness. Leave sufficient amount of slack to allow for intake tube movement. See **Figure 23**.

**17.** Your system contains a CARB EO label for emissions purposes. This label should be placed on the grill/radiator cross member inside the engine compartment, so that it is easily seen by an emissions technician.

**18.** This completes the installation of the Banks Ram-Air Intake system. Check all hose clamps for tightness and connectors for a sure fit and intake tube is not touching any engine components.

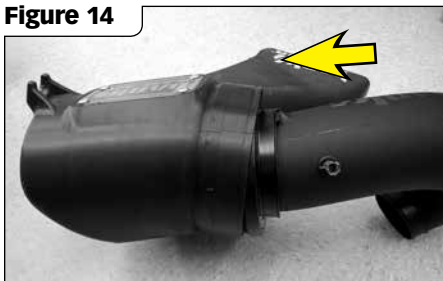

**Figure 16**



**OEM Hose Configuration**

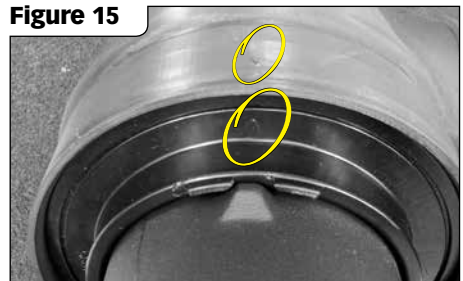

**Figure 17**



**Rerouted Configuration**

**Figure 18**



**Figure 19**

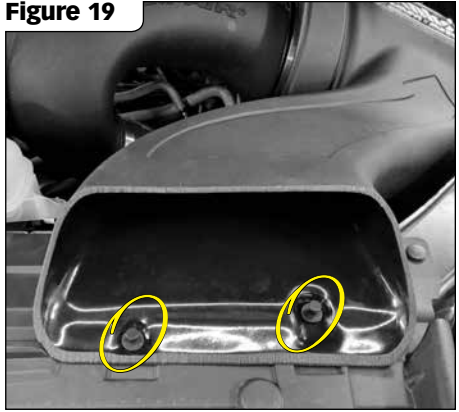

**Figure 20**

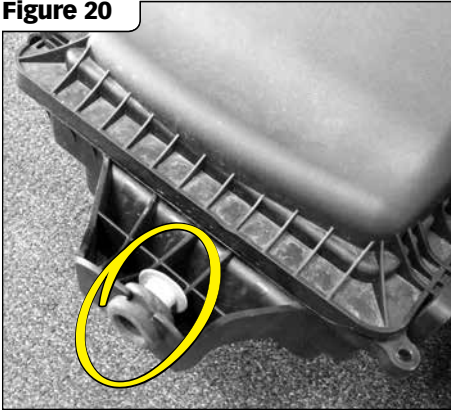

**Figure 21**

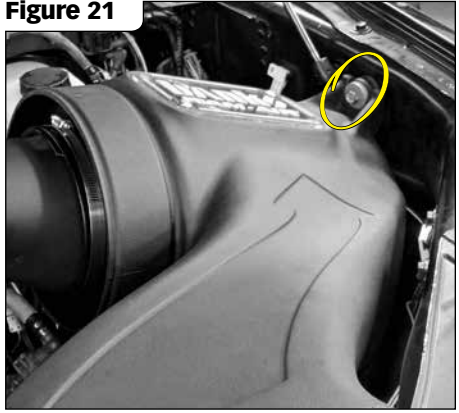

**Figure 22**

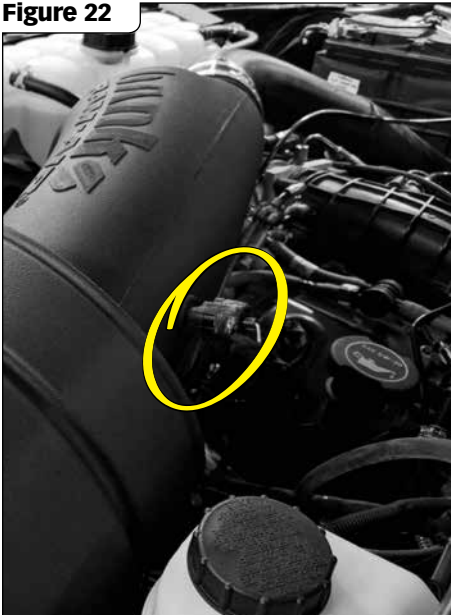

**Figure 23**



# Section 4

## AIR FILTER CLEANING INSTRUCTIONS

### OILED AIR FILTER ONLY

***NOTICE***: The Banks Ram-Air Oiled Air Filter comes pre-oiled and no oiling is necessary for initial installation. Use Banks Ram-Air Filter Cleaning System (part#90094), available from Gale Banks Engineering to service the Air Filter. Follow the instructions included with the cleaning system to clean and re-oil your Bank Ram-Air Oiled Air Filter.

#### 1. PRE-CLEANING

Tap the element to dislodge any large embedded dirt, then gently brush with a soft bristle brush. *NOTE: If complete cleaning is not practical at this time, recoil the element and reinstall in your vehicle.*

#### 2. SPRAY-ON CLEANING

Spray air-filter cleaner liberally onto the entire element and let soak for 10 minutes.

#### 3. PAN CLEANING

Large air-filter elements can be rolled or soaked in a shallow pan of air-filter cleaner. Remove immediately and let soak for approximately 10 minutes.

***NOTICE***: NEVER use gasoline, steam, caustic solutions, strong detergents, high-pressure nozzles, or cleaning solvents to clean the filter element. All of these can cause harm to the filter media as well as SHRINK and HARDEN the rubber end caps.

#### 4. RINSING

Rinse off the element with low-pressure water. Tap water is okay. Always flush from the clean side to dirty side. This removes the dirt

and does not drive it into the filter.

#### 5. DRYING

Always dry naturally. After rinsing, shake off all excess water and let the element dry naturally.

#### 6. AEROSOL OILING

After cleaning air filter always reoil before using. Spray air filter oil down into each pleat with one pass per pleat. Wait 10 minutes and re-oil any white spots still showing.

#### 7. OILING HINTS

Never use a Banks Ram-Air filter without oil (the filter will not stop the dirt without the oil). Use only air filter oil. Air-filter oil is a compound of mineral and animal oil blended with special polymers to form a very efficient tack barrier. Red dye is added to show just where you have applied the oil. Eventually the red color will fade but the oil will remain and filter the air. NEVER USE Automatic Transmission Fluid. NEVER USE Motor Oil. NEVER USE Diesel Fuel. NEVER USE WD40, LPS, or other light-weight oils.

#### 8. REINSTALL

Reinstall your Banks Ram-Air filter element with proper care. Make sure the element seats properly in the filter case. Install the cover making sure it's in the right position. Tighten all the nuts, bolts, screws or clips to factory specifications.

#### 9. DO NOT DISCARD

Affix the "Do Not Discard" sticker to the filter case (included with every Banks replacement element). Make sure you put the sticker in a highly visible place to alert your mechanic not to discard.

#### 10. PERFORMANCE HINTS

Service every 50-100,000 miles on

street-driven applications. Service more often in offroad or heavy-dust conditions. If an air-filter restriction gauge is installed, then change the element when the air-filter restriction reaches 18"–H.O.

**⚠ CAUTION:** **Extremely fine dust from agriculture or offroad use will pull the oil from the element. Frequent reoiling of the element's clean side might be required. Completely service when practicable. For extra protection use an air-filter sealing grease on rubber ends of the element. Service only with air-filter cleaner and air-filter oil.**

## DRY FILTER CLEANING

Clean every 50-100,000 miles on street-driven applications. Clean more often in offroad or heavy-dust conditions. If an air-filter restriction gauge is installed, then change the element when the air-filter restriction reaches 18"–H.O.

### 1. PRE-CLEANING

Carefully tap the air filter element to dislodge any large embedded dirt or debris.

### 2. CLEANING

Spray an appropriate DRY AIR-FILTER CLEANER SOLUTION liberally onto both sides of the entire filter element with the majority applied to the dirty side. Soak for 10 minutes. Do not allow the DRY AIR-FILTER CLEANER SOLUTION to dry on the air filter.

**NOTICE:** **NEVER use gasoline, steam, caustic solutions, strong detergents, high-pressure nozzles, or cleaning solvents to clean the filter element.** All of these can cause harm to the filter media as well as SHRINK and HARDEN the rubber end caps.

### 3. RINSING

Rinse the filter element with cool or warm (not hot) water from the clean side out in order to flush the dirt out of the filter. It may be necessary to use your fingers on the hose to apply light water pressure. Repeat steps 2 and 3, until the water flowing through the media is completely clear of any dirt and debris.

### 4. DRYING

After rinsing, gently shake off excessive water and allow to dry naturally. Re-install the filter onto the intake system, airbox or custom assembly once it is dry or just slightly damp. Follow all original installation instructions.

### 5. REINSTALL

Reinstall your Banks Ram-Air filter element with proper care. Make sure the element seats properly in the filter case. Install the cover making sure it's in the right position. Tighten all the nuts, bolts, screws or clips to factory specifications.

### 6. DO NOT DISCARD

Affix the "Do Not Discard" sticker to the filter case (included with every Banks replacement element). Make sure you put the sticker in a highly visible place to alert your mechanic not to discard.

### 7. PERFORMANCE HINTS

Service every 50-100,000 miles on street-driven applications. Service more often in offroad or heavy-dust conditions. If an air-filter restriction gauge is installed, then change the element when the air-filter restriction reaches 18"–H.O.

-END, SECTION 4-

# Section 5

## PROPER LOGO PLACEMENT

Your system includes two Banks Power logos that have been designed to compliment the Ford badging on your truck. We have provided measurements, which will allow you to place these logos in a position that gives a clean OEM look. See **Figure 24**.

**Figure 24**

### TYPICAL LEFT FENDER



### TYPICAL RIGHT FENDER



Gale Banks Engineering  
546 Duggan Avenue • Azusa, CA 91702  
(626) 969-9600 • Fax (626) 334-1743

Product Information & Sales: (888) 635-4565  
Customer Support: (888) 839-5600  
Installation Support: (888) 839-2700  
[www.bankspower.com](http://www.bankspower.com)